

## 船用家具 Marine Furniture

船用家具作为船上生活和工作的必备部件，是供船上人员学习、工作和日常生活使用的床、柜、桌、椅、箱、橱、架等家具的统称，具有与船体配合、轻巧和不会倾倒的特点。

我公司设计、生产制造并提供现场安装服务的船用家具按材质区分主要有：船用金属家具和铝蜂窝家具；家具按功能用途区分有：床类、柜类、桌椅类和多功能类。

Marine furniture, necessary for life and work onboard, is a general term for all furniture onboard such as bed, cabinet, table, chair, box, cupboard, shelf, etc. Marine furniture has the features of matching with the hull, light and no tipping.

Our company provides design, manufacture and installation services of marine furniture. We have:

Categorized by material: metal furniture and aluminum honeycomb furniture, categorized by function: bed, cabinet, desk, chair and multi-functional furniture;

具体（常用）选型和基本参数见下表：

Specific (commonly used) selection and basic parameters are shown in the following table:

图号 DWG. NO.	名称 DESCRIPTION	基本尺寸/mm GENERAL SIZE			重量(kg) WEIGHT		
		长 L	宽 B	高 H	钢 steel	铝 aluminium	铝蜂窝 aluminum honeycomb
381WHL103G-00/ 381WHL103L-00/ 381WHL103-00	单层软垫柜床 SINGLE BED WITH DRAWER	2000	750	850	86.5	57.2	62.0
			800		95	60.0	68.0
			850		104	63.5	71.2
			900		113	68.0	75.0
			1000		132	74.0	83.5
			1200		165	86.0	89.0
381WHL101G-00/ 381WHL101L-00/ 381WHL101-00	双层柜床 2-TIER BED WITH DRAWER	1950	700	1850	102	94	105.5
		1950	750		115	98.5	110.0
		2000	800		135	107	121.0
		2050	800		140	112	129.0
381WHL102G-00/ 381WHL102L-00/ 381WHL102-00	三层床 3-TIER BED	1950	650	1900	101	99	114
		1950	700	1900	120	104	120
		2000	750	2000	140	113	131
381WHL104G-00/ 381WHL104L-00/ 381WHL104-00	沙发床 SOFA BED	1950	750	1200	111	78	89

表1/ 床类家具选型及基本参数

Table 1/ Selection & basic parameters for bed

注：图号中数字后面单字母“G”代表材质为钢质；“L”代表材质为铝质；其余代表铝蜂窝材质。

Notes: The single letter "G" in the figure indicates that the material is steel; the "L" indicates the material is aluminum alloy, and the rest indicates the aluminum honeycomb material.



## 船用家具 Marine Furniture

图号 DWG. NO.	名称 DESCRIPTION	基本尺寸/mm GENERAL SIZE			重量(kg) WEIGHT		
		长 L	宽 B	高 H	钢 steel	铝 aluminium	铝蜂窝 aluminum honeycomb
381WHL105G-00/ 381WHL105L-00/ 381WHL105-00	床头柜 BEDSIDE CABINET	450	500	550	25.0	12.0	13.0
		550		650	36.0	17.0	15.0
381WHL108G-00/ 381WHL108L-00/ 381WHL108-00	单门衣柜 WARDROBE WITH SINGLE DOOR	450	550	1800	52.0	24.0	30.0
		500		1900	62.0	26.0	35.0
				2000	72.0	30.0	38.5
381WHL109G-00/ 381WHL109L-00/ 381WHL109-00	双门衣柜 WARDROBE WITH DOUBLE DOOR	850	550	1800	87.0	55.0	59.3
		1000		1900	98.0	59.0	64.5
				2000	110.0	63.0	68.5
381WHL107G-00/ 381WHL107L-00/ 381WHL107-00	更衣柜 CLOTHES CHANGING WARDROBE	350	400	1800	47.0	23.0	27.0
		400	450		58.0	25.0	35.0
381WHL111G-00/ 381WHL111L-00/ 381WHL111-00	文件柜 FILE CABINET	450	550	1450	65.0	43.0	48.0
381WHL107G-00/ 381WHL107L-00/ 381WHL107-00	物品柜 ARTICLE CABINET	600	400	1800	47.0	30.0	35.0
				2000	58.0	36.0	42.0
381WHL138G-00/ 381WHL138L-00/ 381WHL138-00	药品柜 MEDICINE CABINET	700	550	1800	75.0	50.0	55.5
				600	2000	81.5	56.5
381WHL134G-00/ 381WHL134L-00/ 381WHL134-00	吊柜 WALL CABINET	600	300	450	48.0	33.0	39.0
				1200	500	60.0	35.0
381WHL139G-00/ 381WHL139L-00/ 381WHL139-00	鞋柜 SHOE BOX	500	320	550	31.0	17.0	22.0
381WHL112G-00/ 381WHL112L-00/ 381WHL112-00	钥匙柜 KEY BOX	350	125	450	18.0	6.0	10.0
		500	100	650	33.0	20.0	25.0

表2/ 柜类家具选型及基本参数

Table 2/ Selection &amp; basic parameters for cabinet

注：图号中数字后面单字母“G”代表材质为钢质；“L”代表材质为铝质；其余代表铝蜂窝材质。

Notes: The single letter "G" in the figure indicates that the material is steel; the "L" indicates the material is aluminum alloy, and the rest indicates the aluminum honeycomb material.



## 船用家具 Marine Furniture

图号 DWG. NO.	名称 DESCRIPTION		基本尺寸/mm GENERAL SIZE			重量(kg) WEIGHT		
			长 L	宽 B	高 H	钢 steel	铝 aluminium	铝蜂窝 aluminum honeycomb
381WHL116G-00/ 381WHL116L-00/ 381WHL116-00	单台座书桌 SINGLE PIER DESK		1000	550	780	61.0	29.0	56.0
				600		70.0	38.0	45.0
381WHL118G-00/ 381WHL118L-00/ 381WHL118-00	双台座书桌 DOUBLE PIER DESK		1200	550	780	86.0	46.0	52.0
				600		90.0	50.0	55.3
				700		86.0	56.0	62.0
381WHL119G-00/ 381WHL119L-00/ 381WHL119-00	转角办公桌 CORNER DESK	主桌 MAIN DESK	1500	700	780	81.0	51.0	55.5
		边柜 SIDE CABINET	800	400	580~745	47.0	17.0	22.0
381WHL117G-00/ 381WHL117L-00/ 381WHL117-00	挂壁书桌 WALL DESK		500	450	600	15.0	5.0	7.5
				700		500	19.5	6.5
381WHL121G-00/ 381WHL121L-00/ 381WHL121-00	海图桌 CHART TABLE		2400	1100	900	159.0	119.0	125.0
				1200	950	171.0	129.0	135.0
381WHL126G-00/ 381WHL126L-00/ 381WHL126-00	餐桌 MESS TABLE		1000	600	750	31.0	11.0	15.0
						1500	35.0	15.0
381WHL122G-00/ 381WHL122L-00/ 381WHL122-00	茶几 SQUARE TEA TABLE		600	400	500	12.0	7.5	9.0
				500		18.0	9.5	11.0
				600		24.0	11.5	13.0
381WHL137G-00/ 381WHL137L-00/ 381WHL137-00	旗箱 FLAG LOCKER		1000	450	900	55.5	39.5	44.5
				1500	500	1050	58.0	41.5
381WHL133G-00/ 381WHL133L-00/ 381WHL133-00	书架 BOOK RACK		500	240	320	9.0	4.5	7.5
				600	350	300	15.0	7.0

表3/ 桌类家具选型及基本参数

Table 3/ Selection &amp; basic parameters for desk

注：图号中数字后面单字母“G”代表材质为钢质；“L”代表材质为铝质；其余代表铝蜂窝材质。

Notes: The single letter "G" in the figure indicates that the material is steel; the "L" indicates the material is aluminum alloy, and the rest indicates the aluminum honeycomb material.



## 船用家具 Marine Furniture

图号 DWG. NO.	名称 DESCRIPTION	基本尺寸/mm GENERAL SIZE			重量(kg) WEIGHT		
		长 L	宽 B	高 H	钢 steel	铝 aluminium	铝蜂窝 aluminium honeycomb
381WHL131G-00/ 381WHL131L-00	座椅 CHAIR	450	450	440	23.0	15.0	
381WHL128-00	单人沙发 ONE-SEATER SOFA	600	650	850			32.0
381WHL129-00	双人沙发 TWO-SEATER SOFA	1200	650	850			38.0
381WHL130-00	三人沙发 THREE-SEATER SOFA	≥1500	650	850			42.0
381WHL132-00	组合式沙发 SECTIONAL SOFA	∞2000	650	850			71.0

表4/ 椅凳类（含沙发）家具选型及基本参数

Table 4/ Selection &amp; basic parameters for chair and stool

注：重量列表中的材质（钢、铝、铝蜂窝）仅表示产品主体基座材质；图号中数字后面单字母“G”代表材质为钢质；“L”代表材质为铝质；其余代表铝蜂窝材质。

Notes: The material(steel, aluminium, alum.honeycomb) in the weight list represents only material of the main body base of the product, the single letter "G" in the figure indicates that the material is steel; the "L" indicates the material is aluminum alloy, and the rest indicates the aluminum honeycomb material.

## ○ 船用金属家具（床类款式） Marine Metal Furniture (Bed Type)

1. 单层软垫柜床（左式）见图1，右式与此对称

SINGLE BED WITH DRAWER (LEFT-STYLE) SHOWN IN FIGURE 1. THE RIGHT-STYLE IS SYMMETRICAL



图1/ 单层软垫柜床（左式）结构示意图

PIC1/ SINGLE BED WITH DRAWER (LEFT-STYLE) STRUCTURE DIAGRAM

2. 双层柜床（左式）见图2，右式与此对称

2-TIER BED WITH DRAWER (LEFT-STYLE) SHOWN IN FIGURE 2. THE RIGHT-STYLE IS SYMMETRICAL

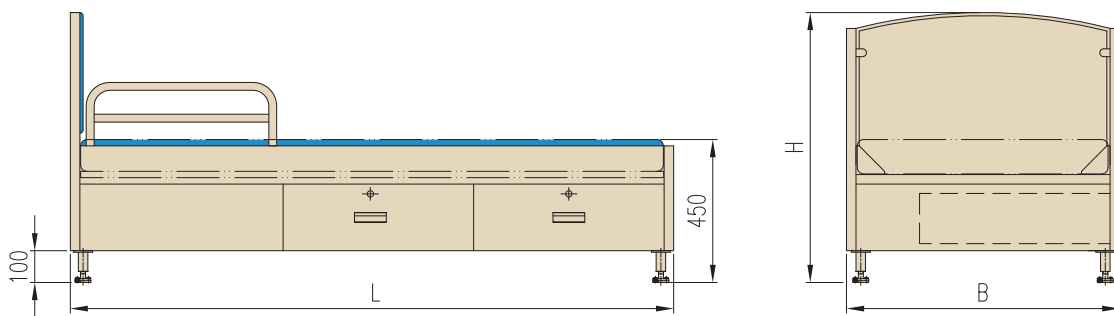

图2/ 双层柜床（左式）结构示意图

PIC2/ 2-TIER BED WITH DRAWER (LEFT-STYLE) STRUCTURE DIAGRAM

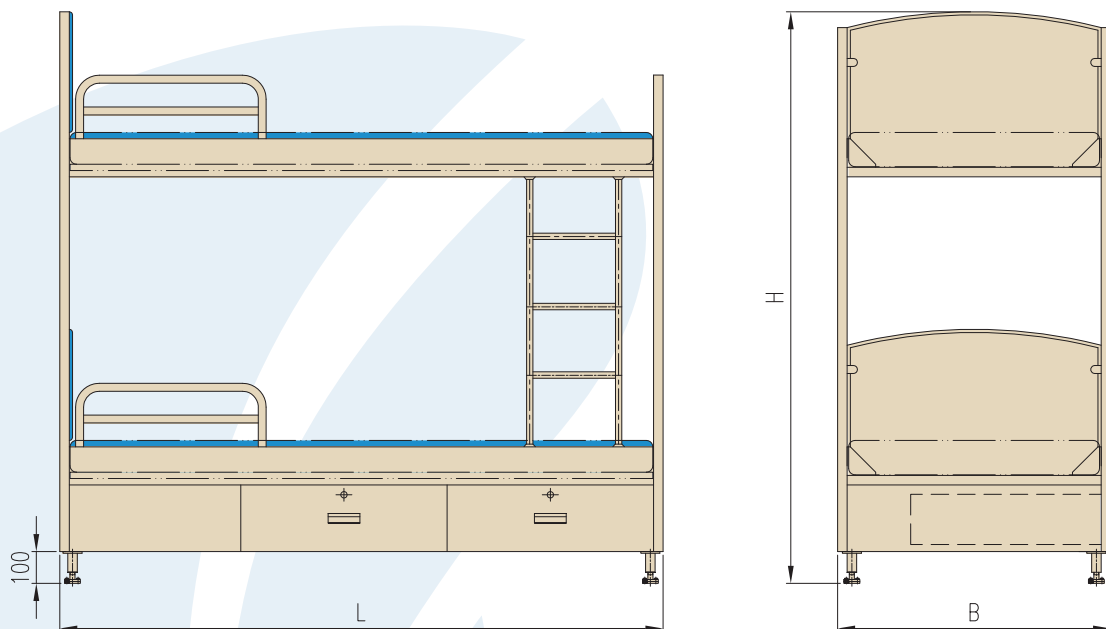

## 船用金属家具(床类款式) Marine Metal Furniture (Bed Types)

3. 三层床(左式)见图3, 右式与此对称.

3-TIER BED( LEFT-STYLE) SHOWN IN FIGURE 3, THE RIGHT-STYLE IS SYMMETRICAL



图3/ 单层软垫柜床 (左式) 结构示意图

PIC3/ 3-TIER BED( LEFT-STYLE) STRUCTURE DIAGRAM.

4. 沙发床 (左式) 见图4, 右式与此对称.

SOFA BED (LEFT-STYLE) SHOWN IN FIGURE 4, THE RIGHT-STYLE IS SYMMETRICAL

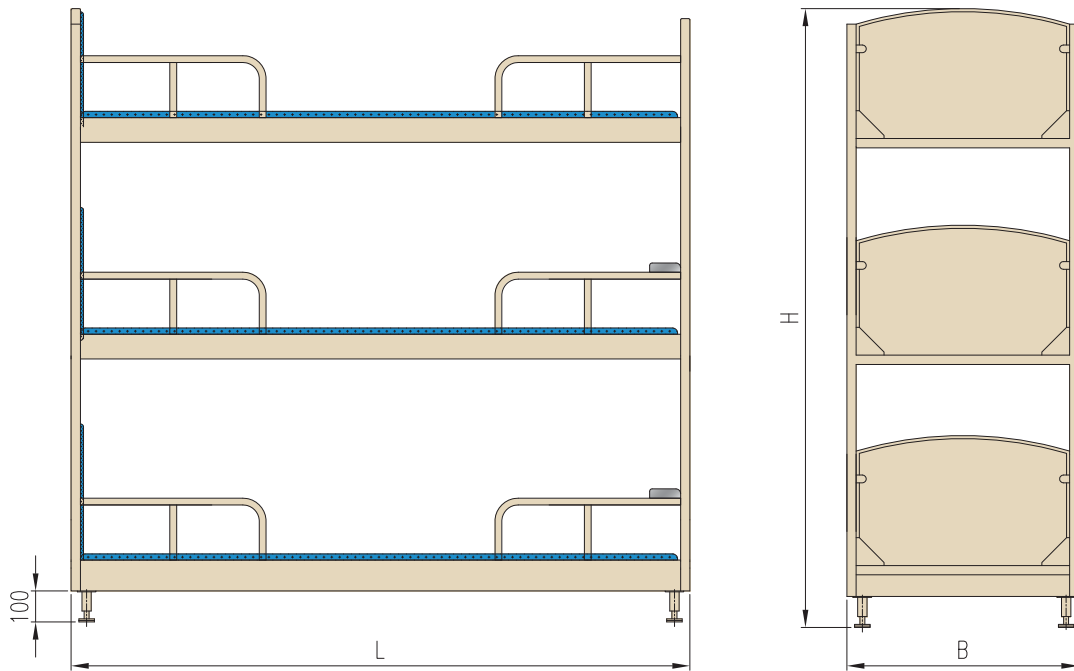

图4/ 沙发床 (左式) 结构示意图

PIC4/ SOFA BED (LEFT-STYLE) STRUCTURE DIAGRAM.

## ○ 船用金属家具（柜类款式） Marine Metal Furniture (Cabinet Type)

### 1. 床头柜，见图1

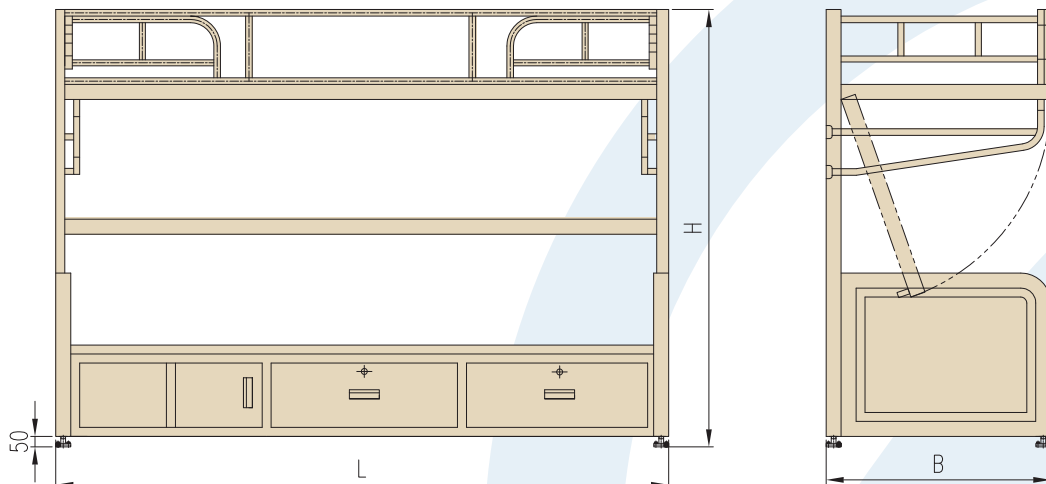
BEDSIDE CABINET SHOWN IN FIGURE 1.



图1/ 床头柜 结构示意图

PIC1/ BEDSIDE CABINET STRUCTURE DIAGRAM

### 2. 单门衣柜（右式）见图2. 右式与此对称

SINGLE DOOR WARDROBE (RIGHT-STYLE) SHOWN IN FIGURE 2, THE LEFT-STYLE IS SYMMETRICAL

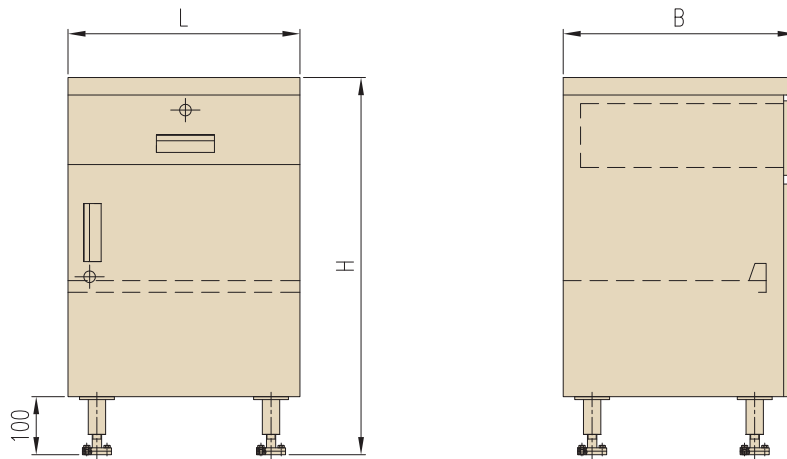

图2/ 单门衣柜（右式）结构示意图

PIC2/ SINGLE DOOR WARDROBE (RIGHT-TYPE) STRUCTURE DIAGRAM

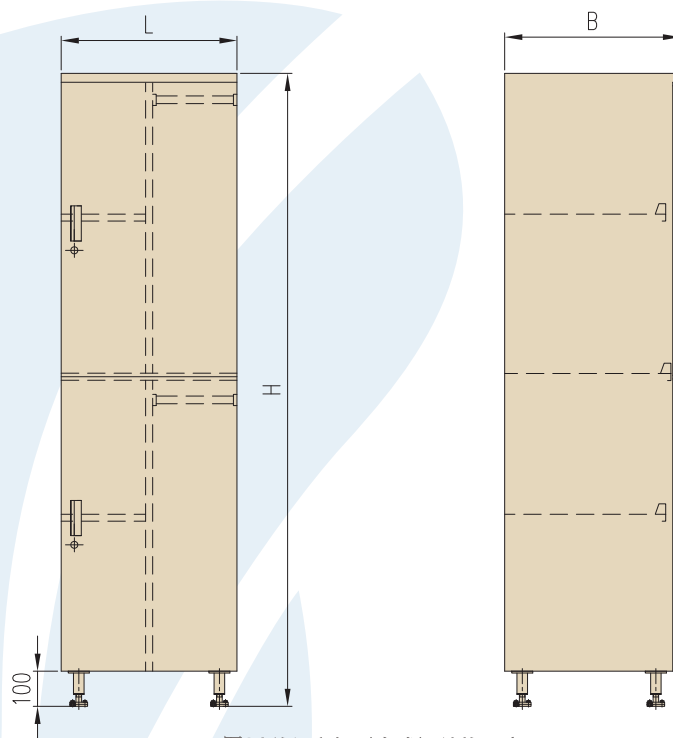

## 船用金属家具（柜类款式） Marine Metal Furniture (Cabinet Type)

1. 双门衣柜，见图3

DOUBLE DOOR WARDROBE SHOWN IN FIGURE 3



图3/ 双门衣柜 结构示意图

PIC3/ DOUBLE DOOR WARDROBE STRUCTURE DIAGRAM

4. 更衣柜，见图4

CLOTHES CHANGING WARDROBE SHOWN IN FIGURE 4

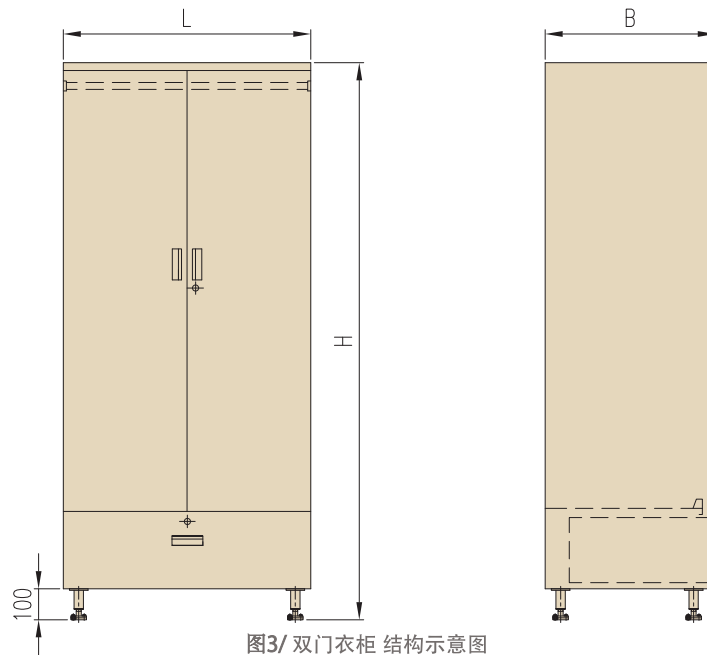

图4/ 更衣柜 结构示意图

PIC4/ CLOTHES CHANGING WARDROBE STRUCTURE DIAGRAM

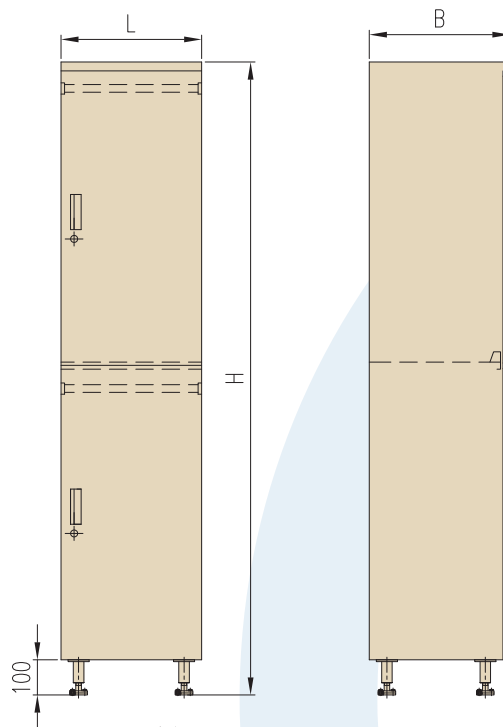

○ 船用金属家具（柜类款式）  
Marine Metal Furniture (Cabinet Type)

5. 文件柜，见图5

FILE CABINET SHOWN IN FIGURE 5



图5/ 文件柜（E型）结构示意图

PIC5/ FILE CABINET (E-TYPE) STRUCTURE DIAGRAM

6. 药品柜，见图6

MEDICINE CABINET SHOWN IN FIGURE 6

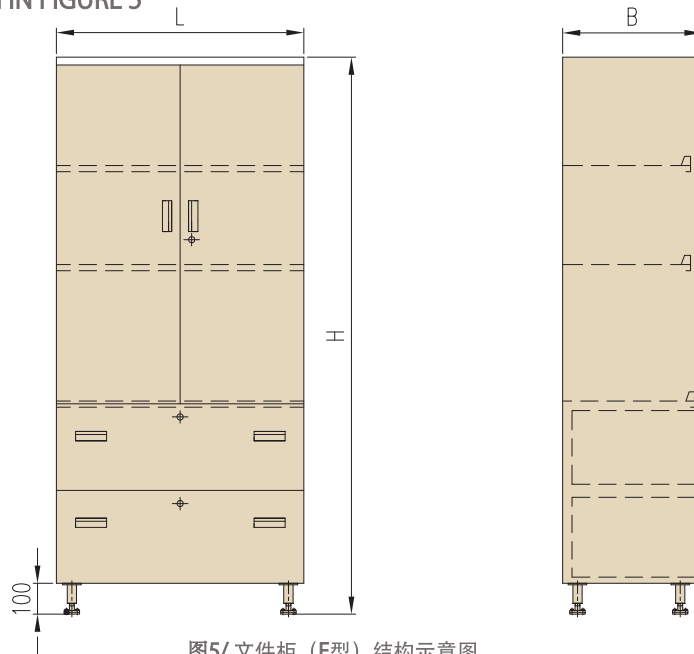

图6/ 药品柜 结构示意图

PIC6/ MEDICINE CABINET STRUCTURE DIAGRAM

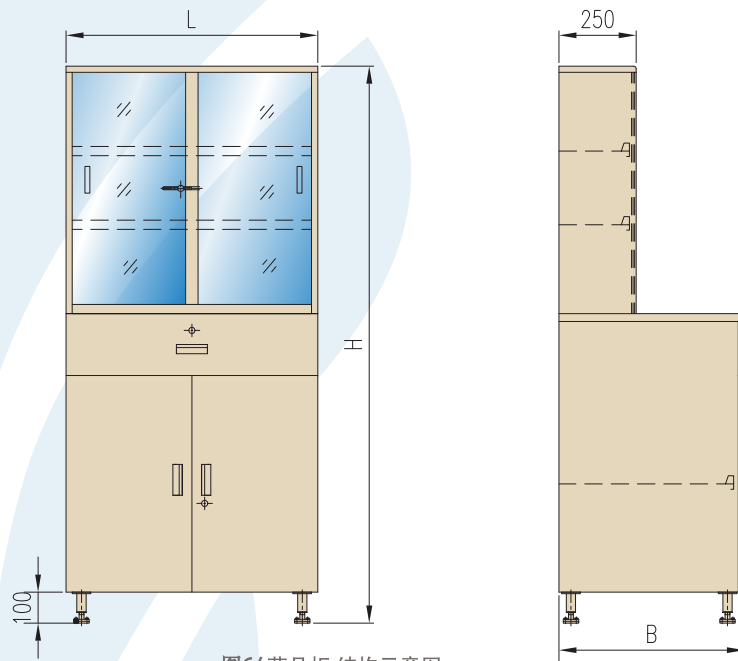

## 船用金属家具（柜类款式） Marine Metal Furniture (Cabinet Type)

7. 吊柜，见图7

WALL CABINET SHOWN IN FIGURE 7



图7/ 吊柜 结构示意图

PIC7/ WALL CABINET STRUCTURE DIAGRAM

8. 钥匙柜，见图8

KEY BOX SHOWN IN FIGURE 8

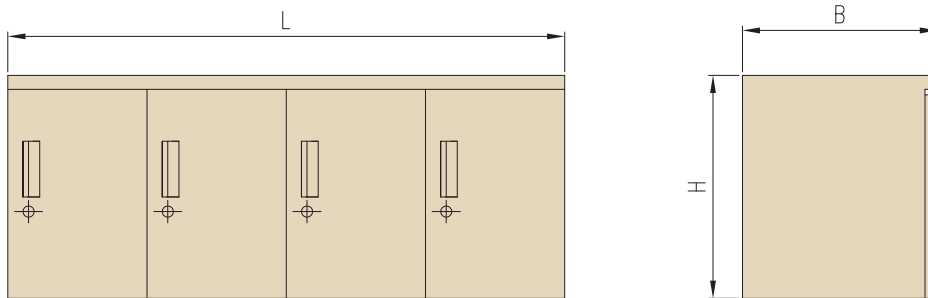

图8/ 钥匙柜 结构示意图

PIC8/ KEY BOX STRUCTURE DIAGRAM

## ○ 船用金属家具（桌类款式） Marine Metal Furniture (Desk Types)

1. 单台座办公桌（右式）见图1，右式与此对称

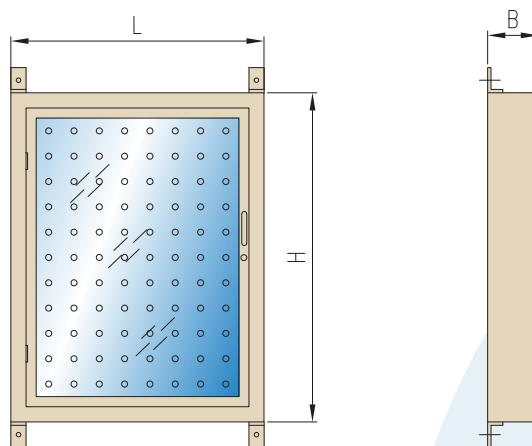
SINGLE PEDESTAL DESK (RIGHT TYPE) SHOWN IN FIGURE 1. THE LEFT-STYLE IS SYMMETRICAL



图1/ 单台座办公桌（左式）结构示意图

PIC1/ SINGLE PEDESTAL DESK (LEFT TYPE) STRUCTURE DIAGRAM

2. 双台座办公桌，见图2

DOUBLE PEDESTAL DESK (E TYPE) SHOWN IN FIGURE 2

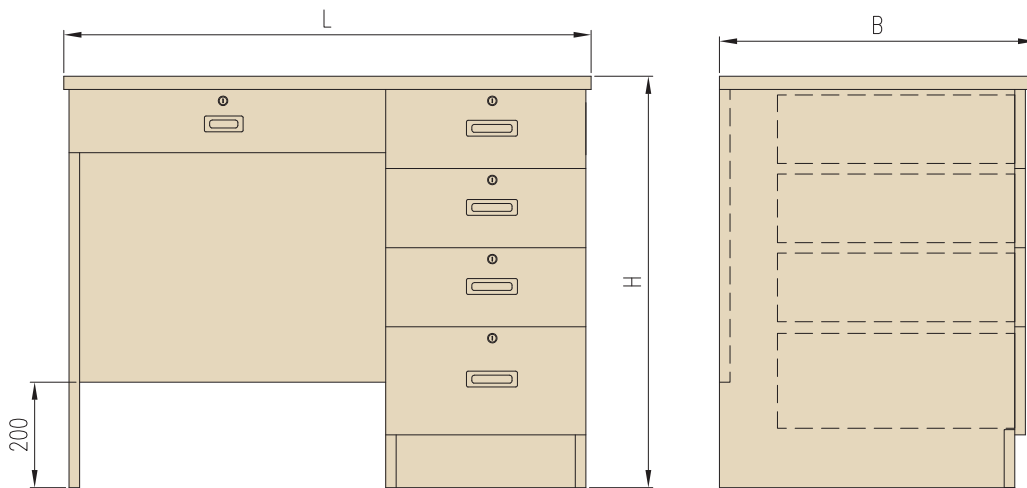

图2/ 双台座办公桌 结构示意图

PIC2/ DOUBLE PEDESTAL DESK STRUCTURE DIAGRAM

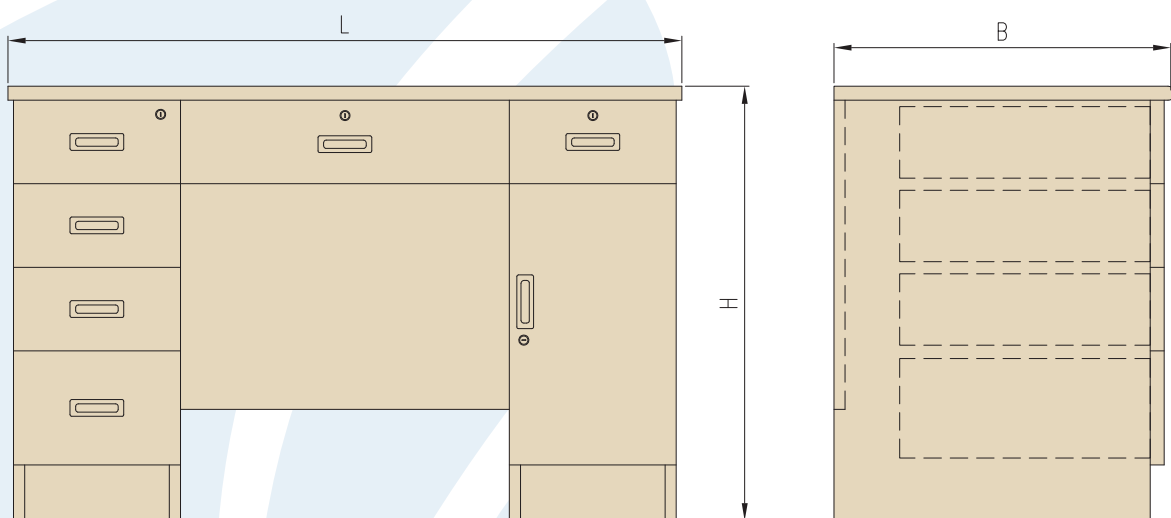

## 船用金属家具（桌类款式） Marine Metal Furniture (Desk Types)

### 3. 海图桌（J141型），见图3

CHART TABLE(J141 TYPE) SHOWN IN FIGURE 3



图3/ 海图桌（J141型）结构示意图

PIC3/ CHEART TABLE(J141 TYPE) STRUCTURE DIAGRAM

### 4. 海图桌（J240型），见图4

CHART TABLE(J240 TYPE) SHOWN IN FIGURE 4

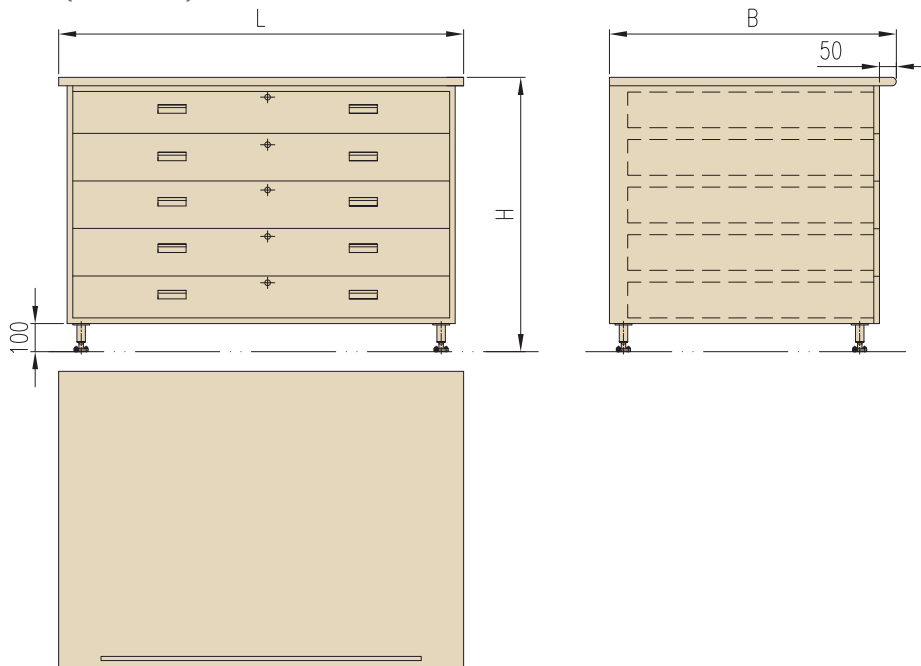

图4/ 海图桌（J240型）结构示意图

PIC4/ CHEART TABLE(J240 TYPE) STRUCTURE DIAGRAM

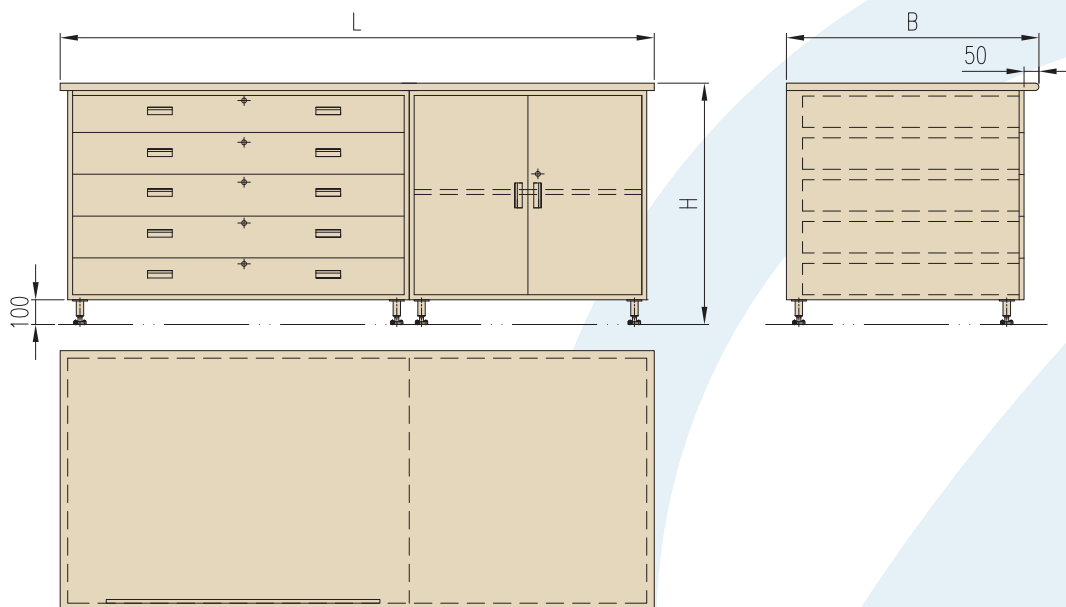

## 船用金属家具（桌类款式） Marine Metal Furniture (Desk Types)

5. 餐桌，见图5

DINING-TABLE SHOWN IN FIGURE 5



图5/ 餐桌 结构示意图

PIC5/ DINING-TABLE STRUCTURE DIAGRAM

6. 书架（P型），见图6

BOOKRACK(P-TYPE) SHOWN IN FIGURE 6

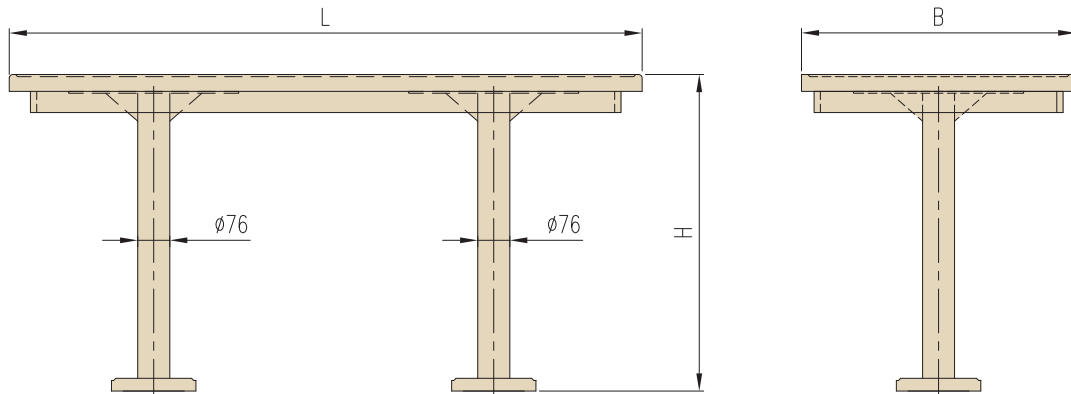

图6/ 书架（P型）结构示意图

PIC6/ BOOKRACK (P-TYPE) STRUCTURE DIAGRAM

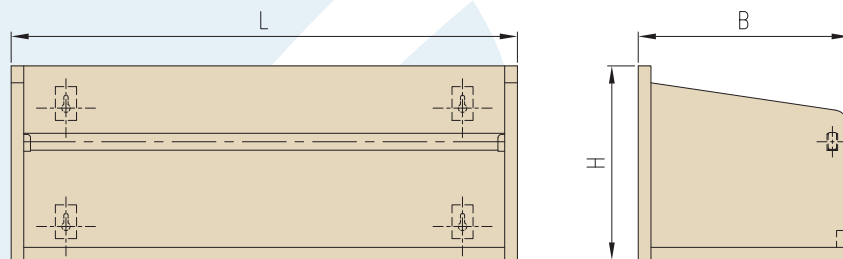

## 船用铝蜂窝家具 Marine Aluminum Honeycomb Furniture

### - 产品介绍 Products Introduction

铝蜂窝家具（全名：防火板贴面铝蜂窝板式家具），由耐高温装饰防火板、铝板、铝蜂窝等材料，采用特种高粘性胶水经过特殊加工工艺复合组成的具有木纹装饰效果的铝蜂窝板材，通过封边（PVC或金属包边）成型，再由优质五金配件组装而成的复合板式家具。

Aluminum Honeycomb Furniture (The Full Name Is Fireproof Sheet Laminate Aluminum Honeycomb Panel Type Furniture), Is Assembled With The Aluminum Honeycomb Panels Made Of High Temperature Fireproof Decoration Sheet, Aluminum Plate And Aluminum Honeycomb Material. Grain Decorative Effect Is Achieved By Special High Viscosity Glue After Special Processing Technology. Assembly Is Done Through The Edge Banding (Pvc Or Metal Edging) Molding Together With High-quality Hardware Parts.

防火板贴面铝蜂窝板 结构形式：

Structure Diagram (Fireproof Sheet Laminate Al.honeycomb Panel):

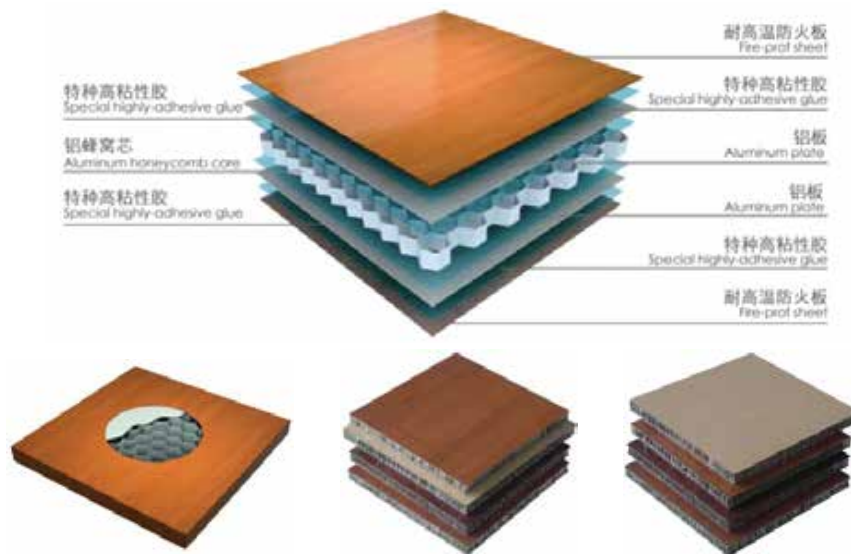

## 船用铝蜂窝家具 Marine Aluminum Honeycomb Furniture

### 1. 产品性能特点

#### Product Performance Characteristics



##### 自然环保 Natural & Environment-friendly

通过海军医学研究所检测：  
具备环保性能。  
Tested by the Naval Medical Research  
Institute: with Environment protection  
performance.



##### 防火阻燃 Fireproof & Flame Resistance

通过远东防火试验中心检测：  
具备低播焰、低烟毒性证书。  
Tested by the Far East Fire Test Center :  
with certificate of low flame rating &  
Low smoke toxicity.



##### 耐候、防潮 Weather Resistance & Moisture Proof

金属板&芯材，配合进口防火板，零吸水  
变形，经久耐用。  
Metal plate and core material, with  
imported fireproof sheet, zero water  
absorption deformation, durable.



##### 抗刮性 Scratch Resistance

材料表面抗刮性优于传统烤漆面料35%。  
scratch resistance of material surface is  
35% better than traditional paint.



##### 色彩丰富、装饰性强 Rich In Color & Perfect Decoration

面材防火板可提供木纹、素色及花色，  
总共300余种颜色。  
Fireproof sheet as the surface material  
provides more than 300 colors  
including wood grain, plain.



##### 可拆式组装 Detachable Assembly

优质五金连接件连接组装，方便现场安  
装或拆卸。  
High quality hardware assembly to  
facilitate field installation and  
disassembly.

### 2. 性能参数（防火板贴面铝蜂窝板）

#### Basic Parameter (Fireproof Sheet Laminate Al.honeycomb Panel)

规格 SPECIFICATION	长度 LENGTH	≤1220x2440mm (根据防火板尺寸) ≤1220x2440mm (According to the fireproof sheet)
	厚度 THICKNESS	常用 15mm、20mm、25mm、30mm Commonly used 15mm、20mm、25mm、30mm
重量 WEIGHT		∞10公斤/平米 (20mm 厚度) ∞ 10Kg/m <sup>2</sup> (20mm Thickness)
弯曲强度 BENDING STRENGTH		4.25x10 <sup>9</sup> 牛·平方毫米 (20mm 厚度) 4.25x10 <sup>9</sup> N·mm <sup>2</sup> (20mm Thickness)
滚筒剥离强度 STRIPPING STRENGTH		40.6°牛·毫米/毫米 (20mm 厚度) 40.6°N·mm <sup>2</sup> (20mm Thickness)

### 3. 主要证书（防火板贴面铝蜂窝板）

#### Main certificate (Fireproof Sheet Laminate Al.honeycomb Panel)

证书 CERTIFICATE	防火证书 FIREPROOF CERTIFICATE	低播焰、低焰毒性证书 (防火板) low flame rating & flame toxicity certificate (fireproof sheet)
	毒性报告 Toxicity report	低毒证书 (防火板贴面铝蜂窝板) low toxicity certificate for fireproof sheet laminate al.honeycomb panel
	长度 LENGTH	低毒证书 (环氧胶) low toxicity certificate for epoxy glue



## ○ 船用铝蜂窝家具（款式） Marine Aluminum Honeycomb Furniture

### 1. 单层软垫柜床

SINGLE BED WITH DRAWER



### 1. 双层柜床

2-TIER BED WITH DRAWER





○ 船用铝蜂窝家具 (款式)  
Marine Aluminum Honeycomb Furniture

3. 沙发床  
SOFA BED



4. 床头柜  
BEDSIDE CABINET



5. 单门衣柜  
WARDROBE WITH SINGLE DOOR



○ 船用铝蜂窝家具 (款式)  
Marine Aluminum Honeycomb Furniture

6. 双门衣柜  
WARDROBE WITH DOUBLE DOOR



7. 文件柜  
FILE CABINET



8. 药品柜  
MEDICINE CABINET



9. 单台座办公桌  
SINGLE PIER DESK



○ 船用铝蜂窝家具 (款式)  
Marine Aluminum Honeycomb Furniture

10. 双台座办公桌  
DOUBLE PIER DESK

11. 转角办公桌  
CORNER DESK



12 海图桌  
CHART TABLE

13. 挂壁书桌  
WALL HANGING DESK

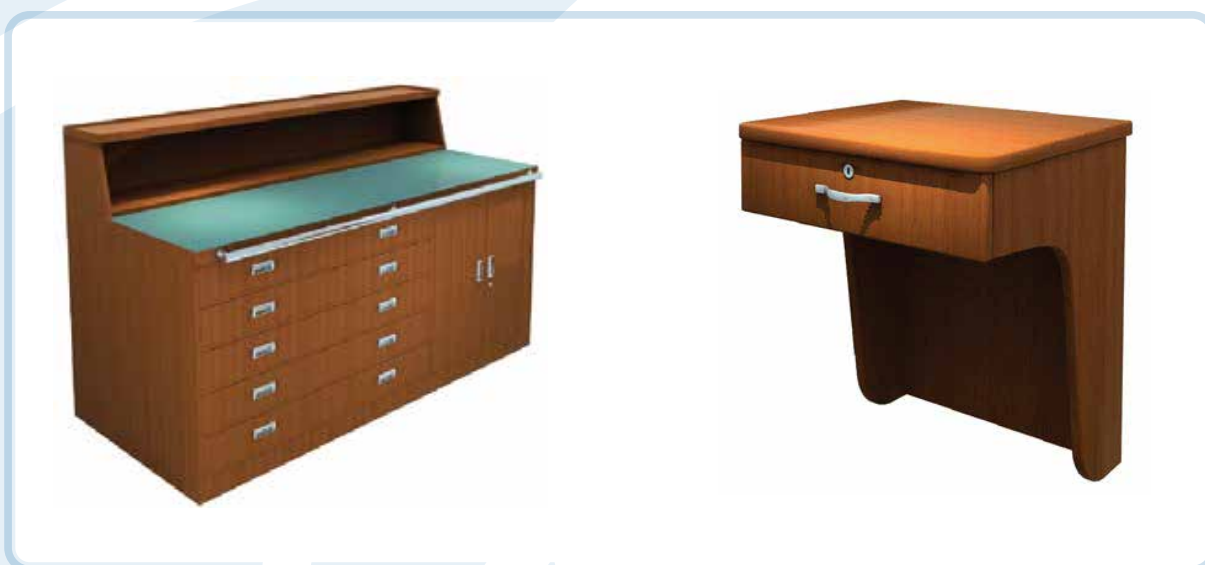



○ 船用铝蜂窝家具（款式）  
Marine Aluminum Honeycomb Furniture

14. 镜面箱  
MIRROR BOX



15. 洗池柜  
WASHING CABINET



16. 吊柜  
HANGING CABINET



17. 书架  
BOOKSHELF



○ 船用多功能家具  
Marine Multi-function Furniture

1. 隐藏式吊顶折叠床  
CONCEALED SUSPENDED CEILING FOLDING BED

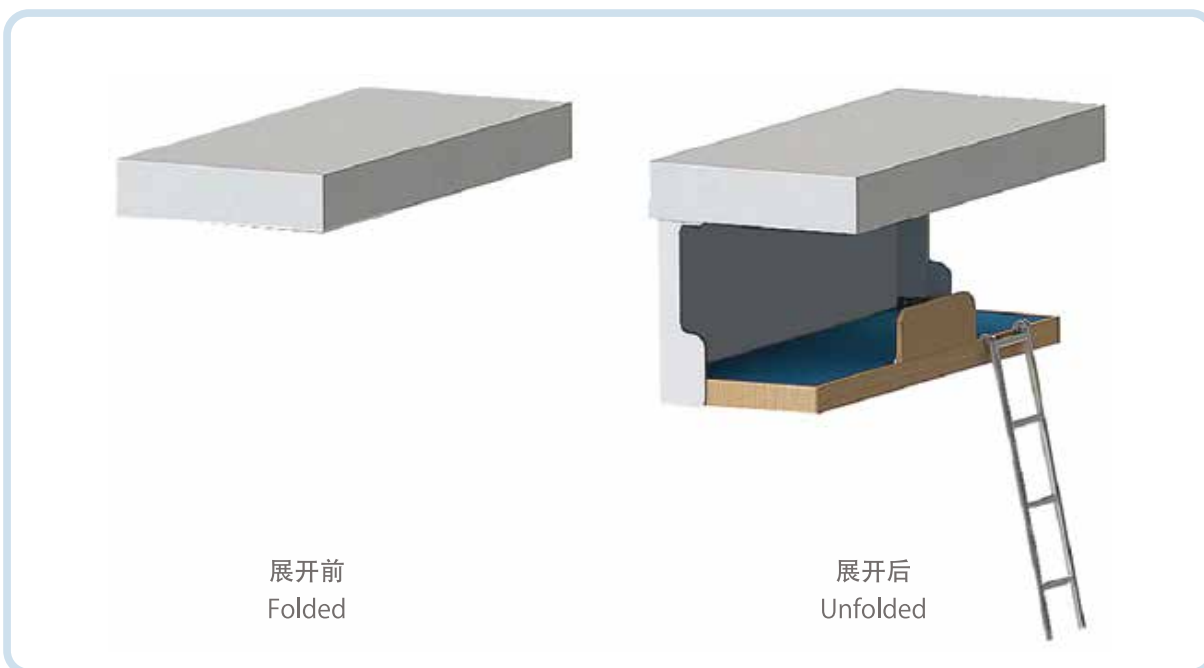

2. 壁柜式翻床  
DOUBLE BED CLOSET





○ 船用多功能家具  
Marine Multi-function Furniture

3. 交错式双层床  
STAGGERED BUNK BED



4. 带折叠桌物品柜  
CABINET WITH FOLDING TABLE



○ 船用铝蜂窝家具（工程案例）  
Marine Aluminum Honeycomb Furniture (Project Cases)

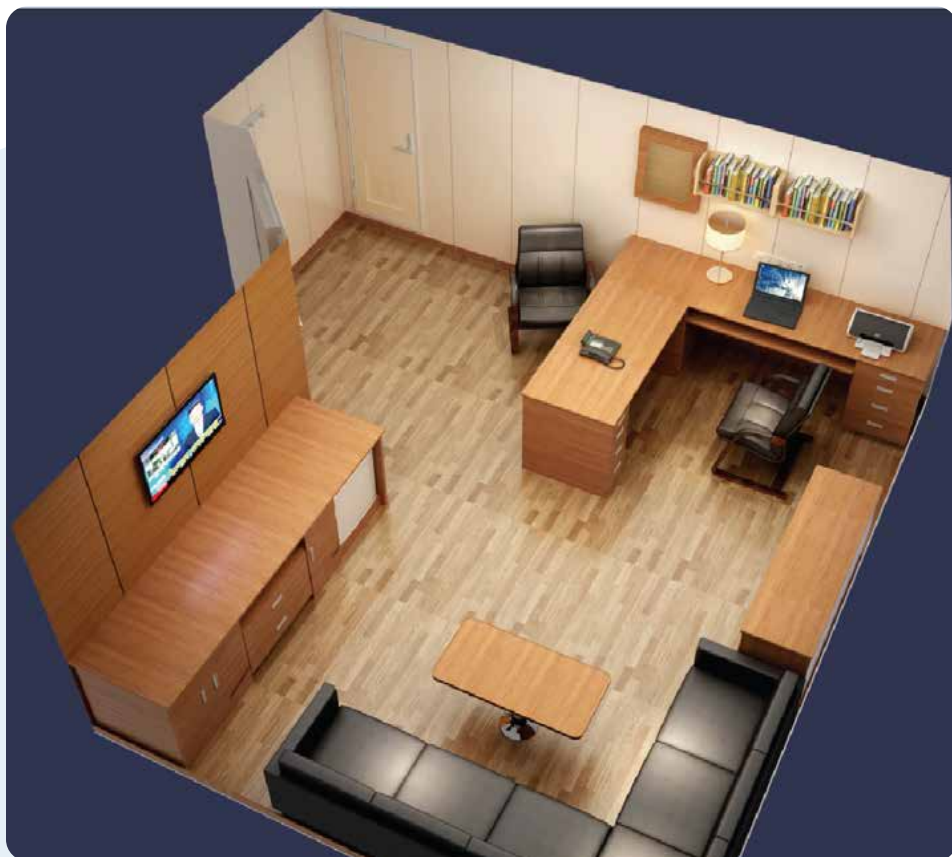



○ 船用铝蜂窝家具（工程案例）  
Marine Aluminum Honeycomb Furniture (Project Cases)





○ 船用铝蜂窝家具 (工程案例)  
Marine Aluminum Honeycomb Furniture (Project Cases)

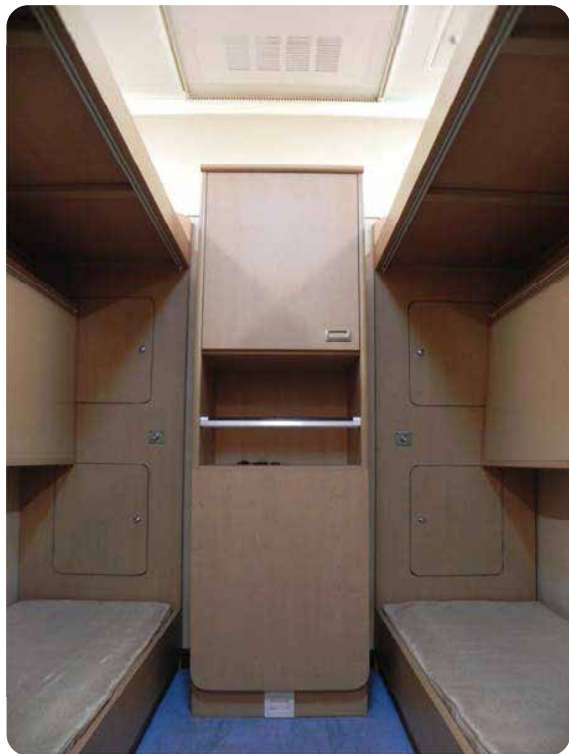
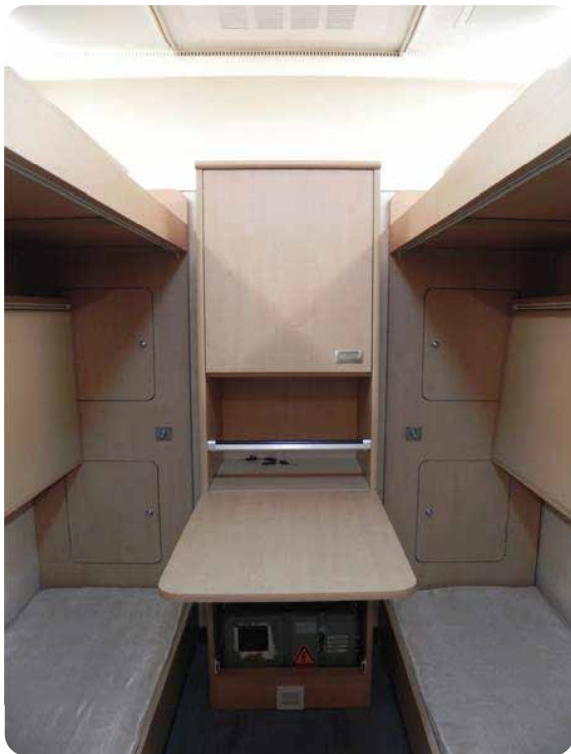



○ 船用铝蜂窝家具（工程案例）  
Marine Aluminum Honeycomb Furniture (Project Cases)

